



WATER BATHS

**MODELS: SWBR17 SWBR17-2**

**SWBR27 SWBR27-2**

Previously designated as

WS17 WS17-2

WS27 WS27-2

RECIPROCATING WATER BATH

INSTALLATION AND OPERATION MANUAL

11/2013

4861582

These units are TUV CUE listed as water baths for professional, industrial or educational use where the preparation or testing of materials is done at approximately atmospheric pressure and no flammable, volatile or combustible materials are being heated. These units have been tested to the following requirements:

CAN/CSA C22.2 No. 61010-1:2012

CAN/CSA C22.2 No. 61010-2-010 + R:2009

UL 61010-1:2004 + R:2005-07 + R:2008-10

UL 61010A-2-010:2002

UL 61010-1:2012

EN 61010-1:2010

EN 61010-2-010:2003

IEC 61010-1:2010

IEC 61010-2-010:2003

Sheldon Manufacturing Inc.  
P.O. Box 627  
Cornelius, Oregon 97113

EMAIL: [tech@Shellab.com](mailto:tech@Shellab.com)

INTERNET: <http://www.Shellab.com>

PHONE: 1-800-322-4897 (503) 640-3000

FAX: (503) 640-1366

# TABLE OF CONTENTS

INTRODUCTION.....	4
General Safety Considerations .....	4
RECEIVING YOUR UNIT .....	5
Inspection Guidelines .....	5
Returning Shipment.....	5
Recording Data Plate Information .....	5
GRAPHIC SYMBOLS.....	6
INSTALLATION.....	7
Environmental Conditions .....	7
Power Source.....	7
Location.....	7
Lifting and Handling.....	7
Oscillation Rack .....	7
Cleaning and Decontamination .....	7
CONTROLS OVERVIEW .....	8
Power Switch.....	8
Main Temperature Controller .....	8
Over Temperature Safety Thermostat (OTP) .....	8
Safety Light .....	8
Oscillation Controller .....	9
Circuit Breaker and Fuse .....	9
OPERATION .....	10
Turning On the Unit.....	10
Bath Cover .....	10
Setting Main Temperature Control .....	10
Calibrating the Main Temperature Control .....	11
Setting the Over Temperature Safety Thermostat .....	11
Setting Oscillation Control .....	11
Setting Samples in Place .....	11
Bath Cover Assembly.....	13
MAINTENANCE .....	14
Draining Tank.....	14
Cleaning .....	14
Storage.....	14
TROUBLESHOOTING .....	15
PARTS LIST .....	18
UNIT SPECIFICATIONS.....	19
SCHEMATICS.....	21

# INTRODUCTION

Thank you for choosing a reciprocating water bath. These units are not intended for use at hazardous or household locations.

Before you use the unit, read this entire manual carefully to understand how to install, operate, and maintain the unit in a safe manner. Your satisfaction with the unit will be maximized as you read about its safety and operational features.

Keep this manual on-hand so it can be used by all operators of the unit. Be sure all operators of the unit are given appropriate training before you put the unit in service.

---

**Note:** Use the unit only in the way described in this manual. Failure to follow the guidelines and instructions in this manual may be dangerous and illegal.

---

## ***General Safety Considerations***

Your water bath and its recommended accessories have been designed and tested to meet strict safety requirements.

For continued safe operation of your water bath, always follow basic safety precautions including:

- Read this entire manual before using the water bath.
- Be sure you follow any city, county, or other ordinances in your area regarding the use of this unit.
- Use only approved accessories. Do not modify system components. Any alterations or modifications to your water bath may be dangerous and will void your warranty.
- Always plug the unit's power cord into a grounded electrical outlet that conforms to national and local electrical codes. If the unit is not grounded, parts such as knobs and controls may conduct electricity and cause serious injury.
- Do not connect the unit to a power source of any other voltage or frequency beyond the range stated on the power rating overlay at the rear of the unit.
- Do not modify the power cord provided with the unit. If the plug does not fit an outlet, have a proper outlet installed by a qualified electrician.
- Avoid damaging the power cord. Do not bend it excessively, step on it, place heavy objects on it. A damaged cord can easily become a shock or fire hazard. Never use a power cord after it has become damaged.
- Do not position equipment in a manner that prohibits access to power cord.
- Do not attempt to move the unit during operation or before the unit has been allowed to cool.

## RECEIVING YOUR UNIT

Before leaving our factory, all units are packaged in high quality shipping materials designed to provide protection from transportation related damage.

Once a unit leaves our factory, however, safe delivery becomes the responsibility of the carrier who is liable for loss or damage to your unit. Damage sustained during transit is not covered under your unit warranty.

When you receive your unit, inspect it for concealed loss or damage to its interior and exterior. Should you find any damage to the unit, follow the carrier's procedure for claiming damage or loss.

### ***Inspection Guidelines***

Carefully inspect the shipping carton for damage. If the carton is damaged, report the damage to the carrier service that delivered the unit.

If the carton is not damaged, open the carton and remove its contents. Verify that all of the following equipment is included in the crate:

- One (1) Bathcover
- Two (2) Thermometer Clips
- One (1) Manual
- One (1) Shaker Basket

Carefully check all packaging before discarding. Save the shipping carton until you are sure everything is in order.

### ***Returning Shipment***

If you must return the unit for any reason, first contact your service representative for authorization. You will be asked to provide the data plate information. See Recording Data Plate Information.

### ***Recording Data Plate Information***

Once you have determined the unit is free from damage, locate the data plate at the back of the unit. The data plate indicates your unit's model number and serial number. Record this information below for future reference.













**Table 1. Data Plate Information**

<b>Model Number</b>	
<b>Serial Number</b>	
<b>Part Number</b>	
<b>Voltage</b>	

# GRAPHIC SYMBOLS

Your unit is provided with a display of graphic symbols that should help in identifying user adjustable components.

**Table 2. Symbols**

Symbol	Identification
	Indicates that you should consult your operator's manual for further instructions.
	Indicates "Temperature"
	Indicates "Over Temperature Protection"
	Indicates "AC Power"
	Indicates the power is "ON"
	Indicates the power is "OFF"
	Indicates "Protective Earthground"
	Indicates "Up" and "Down" respectively
	Indicates "Manually Adjustable"
	Indicates "Potential Shock Hazard" behind partition
	Indicates "Hot Surface"
	Indicates " <b>Unit should be recycled</b> " (Not disposed of in land-fill)

# INSTALLATION

Your satisfaction and safety require a complete understanding of this unit. Read the instructions thoroughly and be sure all operators are given adequate training before attempting to put the unit in service.

This equipment must be used only for its intended application; any alterations or modifications will void your warranty. Local city, county, or other ordinances may govern the use of this equipment. If you have any questions about local requirements, please contact the appropriate local agency. The end user may perform installation.

Customer service should be contacted for operating conditions outside these limits.

## ***Environmental Conditions***

Under normal circumstances these units are intended for use indoors, at room temperatures between 18° and 40°C, at no greater than 80% relative Humidity (at 25°C) and with a supply voltage that does not vary by more than 10% from the data plate rating. This equipment should not be operated at an altitude exceeding 2000 meters. Installation category is **II**, pollution degree 2. Customer service should be contacted for operating conditions outside of these limits.

## ***Power Source***

Check the data plate for voltage, cycle, and ampere requirements. If matched to your power source, plug the power cord into a grounded outlet.

Voltage should not vary more than  $\pm 10\%$  from the data plate rating.

These units are intended for 50/60-HZ application. A separate circuit is recommended to prevent damage to the unit due to overloading or circuit failure.

## ***Location***

In selecting a location, consider all conditions that might affect performance, such as heat from radiators, ovens, autoclaves, etc. Avoid direct sun, fast-moving air currents, heating and cooling ducts, and high traffic areas. Allow a minimum of 10 cm between the unit and any walls or partitions that might obstruct free airflow.

## ***Lifting and Handling***

These units can be heavy for some people and care should be taken to use appropriate lifting devices that are sufficiently rated for these loads. Units should only be lifted from their bottom surfaces. Handles and knobs are not adequate for lifting or stabilization. The unit should be completely restrained from tipping during lifting or transport. All moving parts such as trays or covers should be removed during transfer to prevent shifting and damage.

## ***Oscillation Rack***

The oscillation rack is installed in the bath when packed for shipping. There is a reciprocating arm that extends from the motor housing to the rack. An adjustable bearing is at the bath end of the arm that slides over the locking pin at the top of the rack. This bearing must be in place over the locking pin before the rack will oscillate.

## ***Cleaning and Decontamination***

In the event hazardous material is spilled onto or into the equipment appropriate decontamination must be carried out. If there is any doubt about the compatibility of decontamination or cleaning agents with parts of the equipment or with material contained, please contact the manufacturer.

Units are cleaned at the factory, but not sterilized. Remove any racks if assembled and clean the bath with a disinfectant that is suitable for your application. See **Maintenance Section** for cleaning instructions and precautions.

## CONTROLS OVERVIEW

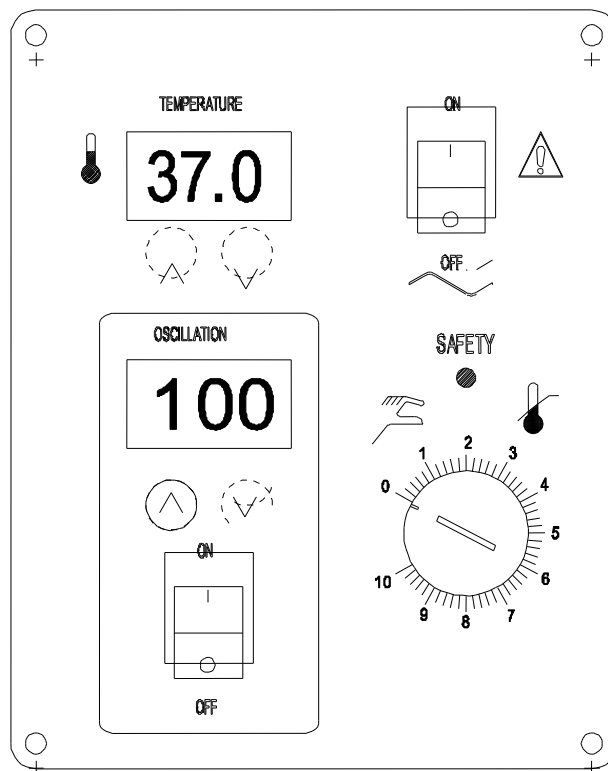

Figure 1. Controls Illustration

### **Power Switch**

The Green I/O (On/Off) power switch, located in the top right hand corner of the control panel, controls all power to the unit. It must be in the I position to be ON and illuminated before any systems are operational. The on/off switch must remain easily accessible at all times.

### **Main Temperature Controller**

This control is marked TEMPERATURE and consists of the digital display and UP and DOWN arrow pads for inputting set point temperatures and calibration.

### **Over Temperature Safety Thermostat (OTP)**

This control is marked SAFETY and is completely independent of the Main Temperature Controller. The Safety guards against any failure of the Main Controller that would allow the temperature to rise past the set point. If the temperature rises to the Safety set point, the Safety takes control of the heating element and allows continued use of the water bath until the problem can be resolved or service can be arranged. The control is adjusted using a screwdriver or a small coin. (See Setting Main Temperature Control for more information.)

### **Safety Light**

This pilot lamp is located just above the OTP and comes ON whenever the Safety Thermostat is activated. This light should never be on during normal operating conditions.



## ***Oscillation Controller***

This control is marked OSCILLATION and consists of the digital display and UP and DOWN arrow pads for inputting selected oscillations per minute.

To enable oscillation, this switch must be in the I position. This switch DOES NOT have to be ON to adjust the oscillation set point.

## ***Circuit Breaker and Fuse***

This control provides additional protection for the unit's electrical circuitry against power fluctuations. The circuit breaker (non-CE models) is adjacent to the power cord, and when tripped must be reset by pushing in the extended button before the unit will continue to operate. The fuse (on CE models in place of the circuit breaker) is located within the power inlet where the detachable cord set connects to the unit. When blown, the fuse must be replaced before the unit can continue operation. Not shown in Figure 1.

# OPERATION

---

**Warning:** These baths are not intended for use as acid baths. Use as an acid bath will cause severe damage to bath components and void your warranty. Do not use deionized water, tap water, or chemicals. USE DISTILLED WATER ONLY.

---

## ***Turning On the Unit***

To turn on the unit, perform the following steps:

1. Check power supply against unit serial plate; they must match.
2. Plug service cord into the electrical outlet. If supplied with a detachable cordset, plug the female end into the unit inlet and the male plug into the power supply. Verify that units requiring a fuse have the fuse installed in the power inlet.
3. Fill bath to your required depth with DISTILLED WATER. DO NOT USE TAP WATER, DEIONIZED WATER, OR CHEMICALS. Normal depth is 5 ½ inches (14 cm), but depth must be at least 2 inches (5 cm) over the bottom of the rack. Check water level frequently, add water to appropriate levels if needed. At higher operating temperatures, or under circumstances where a cover cannot be used, it will be necessary to check the water level more frequently.
4. Push the Main power switch to the ON position and turn the Over Temperature Safety Thermostat to its maximum position, clockwise.

## ***Bath Cover***

Using the bath cover supplied with your accessories will accelerate heat-up time and reduce evaporation. The cover must be used to reach set points above 60°C. The bath cover is not designed to be airtight and create a pressurized environment.

There is a half-inch, plugged hole at the edge of the cover. This plug can be removed and a thermometer can be inserted using the small thermometer clip when calibrating with the cover on. The larger clip is for calibrating without the cover. See Figure 2 for placement of these clips.

## ***Setting Main Temperature Control***

To enter set point mode on the control, push and release either the UP or DOWN arrow pad one time and the digital display will start to blink from bright to dim. While blinking, the digital display shows the set point that can be changed using the UP or DOWN arrow pads. If the arrow pads are not pressed for five (5) seconds, the display will stop blinking and will revert to reading the actual temperature in the bath. Allow at least two (2) hours for the temperature to stabilize.

---

**Warning:** If the tank boils dry while containing plastic ware, the plastic will melt. If you intend to use test tube racks, remember that plastic coated wire racks may wear and expose metal that can cause damage. Preferably, use all plastic racks.

---

**Note:** The heating element of this bath does not contact the tank bottom and will not burn out if the tank is allowed to run dry. However, a tank going dry may strain interior surfaces so this should not be allowed to occur.

---

## ***Calibrating the Main Temperature Control***

We recommend that you calibrate your unit once it has been installed in its working environment and the chamber temperature has been stable at the set point for several hours.

1. Place a calibrated reference thermometer in the bath (a thermometer clip is provided with the accessories package). Allow the thermometer to reach temperature and remain stable for one (1) hour.
2. Compare the reading on the reference thermometer with the temperature control display. If there is a difference, put the display into calibrate mode by pressing both the UP and DOWN arrow pads at the same time until the two (2) outside decimal points begin to blink.
3. When the decimal points are blinking, press the UP or DOWN arrow pad to adjust the display to match the reference thermometer. If the arrow pads are not pressed within five (5) seconds the display will revert to showing the temperature within the bath.
4. Allow the unit to stabilize again, and repeat calibration if necessary.

## ***Setting the Over Temperature Safety Thermostat***

To set the Over Temperature Safety Thermostat, perform the following steps:

1. Verify that the Safety Thermostat was set to its maximum position to allow the water bath to stabilize.
2. Turn the Safety Thermostat counterclockwise until the Safety indicator light turns on.
3. Turn the Safety Thermostat clockwise until the Safety indicator light turns off.
4. Turn the thermostat clockwise again, two of the smallest divisions on its scale past the point where the indicator light went out. This will set the Safety Thermostat at approximately 1°C above the Main Temperature set point.

## ***Setting Oscillation Control***

The oscillation switch DOES NOT need to be ON to adjust oscillation set point (see **Oscillation Controller**). To enter the set point mode on the control, push and release either the UP or DOWN arrow pad one time and the display will start to blink on and off.

While blinking, the digital display is showing the RPM (Rotations Per Minute) set point, which can be changed by pushing the UP and DOWN arrow pads. The range for this set point is 20 - 200 RPM. If the arrow pads are not pressed for five (5) seconds, the display will stop blinking and revert to its original RPM value.

## ***Setting Samples in Place***

With the bath temperatures and oscillation set points adjusted, the unit is ready for operation.

1. Place samples on the oscillation rack as desired.
2. If you are using flask clamps on your oscillation rack, remove the rack and place samples in clamps then put the rack back in place (see Oscillation Rack).
3. Put the bath cover in place if desired and turn the oscillation switch to the ON position.

## Drive Cam Adjustment Illustration

1. Remove the cover from the drive arm housing.
2. Using an appropriate tool (typically a 1/8" allen wrench), loosen and remove the drive screw holding the stroke arm to the Drive Cam.
3. Determine the desired stroke length using the diagram below.
4. Carefully align the stroke arm end to the selected position.
5. Insert the drive screw through the stroke arm end bearing and tighten using an appropriate tool.

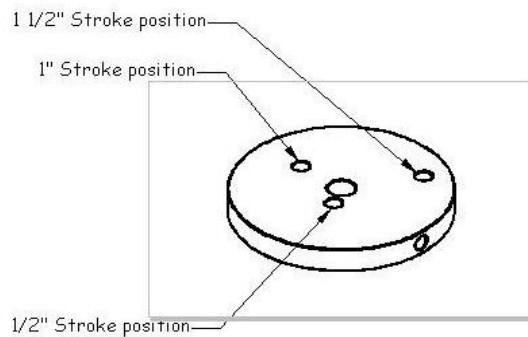

7500503

**Note:** If the unit fails to operate as specified, please review Section 8. TROUBLESHOOTING prior to calling Customer Service.

### FLASK LAYOUT

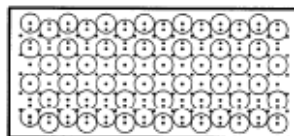

25ML FLASK LAYOUT

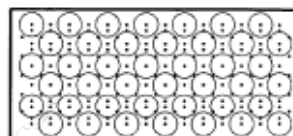

50ML FLASK LAYOUT

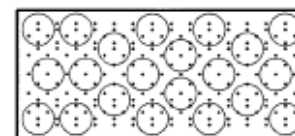

125ML FLASK LAYOUT

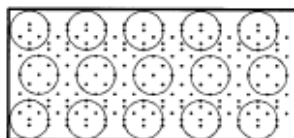

250ML FLASK LAYOUT

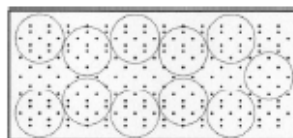

500ML FLASK LAYOUT

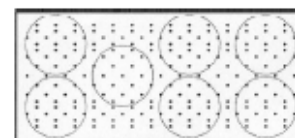

1000ML FLASK LAYOUT

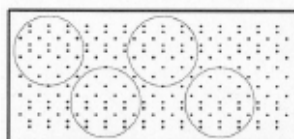

1500ML FLASK LAYOUT

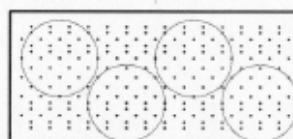

2000ML FLASK LAYOUT

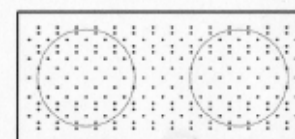

4000ML FLASK LAYOUT

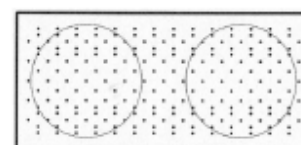

6000ML FLASK LAYOUT

**Figure 2. Bath Cover Clip Placement**

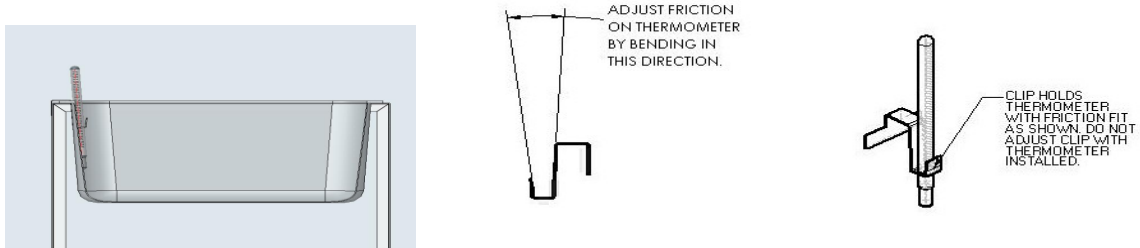

**Note:** Water bath thermometer must be placed so that the bulb is always fully immersed. The thermometer must not touch the sides or the bottom of the bath tank.

### ***Bath Cover Assembly***

To assemble the bath cover, perform the following steps:

Insert 2 self-tapping screws through the respective cover holes and into the holes in the handle, leaving the first self-tapping screw loose to assure proper alignment. Firmly fasten both screws into place. Do not over-tighten.

Handle Part#3800609

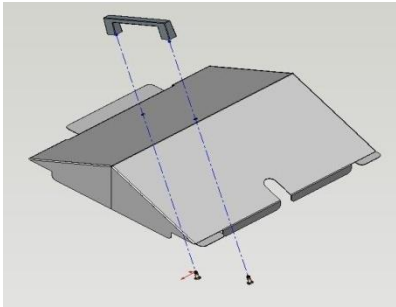

# MAINTENANCE

---

**Warning:** Prior to any maintenance or service on this unit, disconnect the power cord from the power supply and the drain water from the tank. Before reattaching the unit to its power supply, be sure all volatile and flammable cleaners are evaporated and dry.

---

## ***Draining Tank***

1. Position the left side of the water bath over a sink or appropriate receptacle large enough to hold the quantity of water to be drained (15 liters or 4 gallons for the SWBR17 and SWBR17-2 (WS17 WS17-2) or 27 liters or 7.1 gallons for the SWB27 and SWBR27-2 (WS27 WS27-2).
2. Using a small wrench, remove the plug from the drain tube and allow the water to flow out. The drain tube is supplied with 1/8-inch female pipe threads.
3. The drain plug could be replaced with a tube fitting or valve, whichever is convenient for your installation.

## ***Cleaning***

1. Clean the water bath with mild soap and water solution. DO NOT USE chlorine-based bleaches, as they will damage the tank interior. DO NOT USE spray cleaners that may contain solvents, which could leak through openings and cracks and harm electrical part coatings. Failure to do this may permanently damage the unit.
2. Rinse the water bath with clean water and wipe dry with a soft cloth. Stainless steel does not rust, but foreign materials in the tank may rust or leave rust spots. If corrosion is seen, scrub out the stains with a mild abrasive, never steel wool.

## ***Storage***

If the unit is to be shut down for an extended period of time, the tank must be emptied and cleaned as described above. No adjustments to controls should be necessary when the unit is put back in service.

If you are shutting the unit down for transport, perform the following steps:

1. Turn the unit off.
2. Disconnect from the power supply.
3. Remove the oscillating rack and bath cover.
4. Empty and clean the tank.
5. Please see Lifting and Handling for further instruction.
6. No maintenance is required on any of the electrical components.

# TROUBLESHOOTING

Should the unit malfunction, use this section to determine the problem and resolution. Troubleshooting topics include:

- Temperature
- Mechanical
- Other

**Table 3. Temperature Troubleshooting**

Problem	Possible Cause	Solution
Temperature too high	Main controller set too high	See Setting Main Temperature Control
	Main controller failed on	Call customer service.
	Wiring error	Call customer service.
Display reads "HI" or "400"+	Probe is unplugged	Call customer service.
	Probe is broken or wire to the sensor is broken.	Call customer service.
Temperature spikes over set point then settles to set point.	Calibration issue	Recalibrate. See Calibrating the Main Temperature Control.
Temperature is too low	Over Temperature Safety is set too low.	See Setting the Over Temperature Safety Thermostat. See Setting Main Temperature Control.
	Bath temperature not recovered from water being added.	Wait for display to stop changing.
	Unit not recovered from power failure or being turned off.	Bath will need a minimum of 2 hours to warm up and stabilize.
	Element failure	Compare current draw to data plate.
	Main controller failure	Confirm with front panel lights that controller is calling for heat.
	Over Temperature Safety failure	Confirm with Safety light that Thermostat is operating correctly.
	Wiring problem	Check all functions and compare wiring to the wiring schematic, especially around any areas recently worked on.
	Loose connection	Call customer service.
Display reads "LO" but heating all the time	Control failure	Call customer service.
Display reads "LO" and not heating	Sensor plugged in backwards	Call customer service.
Unit will not heat over a temperature that is below set point	N/A	Confirm that amperage and voltage match data plate.
	N/A	Confirm that set point is set high enough and that the Over Temperature Safety is not activated.

Problem	Possible Cause	Solution
	N/A	Check calibration. Using independent thermometer, follow instructions in Calibrating the Main Temperature Control.
	N/A	Put the cover on.
Unit will not heat up at all	N/A	Check amperage. Amperage should be virtually at maximum rated (data plate) amperage.
	N/A	Do all controller functions work? Amperage should be virtually at maximum rated (data plate) amperage.
	N/A	Set the Over Temperature Safety higher.
	N/A	Has the fuse or circuit breaker blown?
Indicated bath temperature unstable	Fluctuating by $\pm 0.1$ ?	May be normal, especially without the use of bath cover.
	Ambient room temperature is radically changing	Temperature fluctuation due to door opening or room airflow from heaters or air conditioning. Stabilize ambient conditions.
	Calibration sensitivity	Recalibrate. See Calibrating the Main Temperature Control. Call customer service if recalibration does not resolve fluctuation.
	Bath not full	Assure that the bath is at least 1/3 full.
	Over Temperature Safety set too low	Be sure that Safety set point is more than 5 degrees over desired Main set point; check if Safety light is on continuously; turn controller knob completely clockwise to see if problem solved then follow instructions in Setting the Over Temperature Safety Thermostat for correct setting.
	Electrical noise	Remove nearby sources of RFI including motors, arcing relays or radio transmitters
	Bad connection on temperature sensor or faulty sensor	Call customer service.
Will not maintain set point	N/A	Assure that set point is at least 5 degrees over ambient room temperature.
	N/A	See if ambient is fluctuating.
Display and Reference thermometer do not match	N/A	See Calibrating the Main Temperature Control.
	Temperature sensor failure	Call customer service.
	Controller failure	Call customer service.
	N/A	Allow at least two hours to stabilize.
	N/A	Verify the reference thermometer is calibrated.
Cannot adjust set points or calibration	N/A	Turn entire unit off and on to reset.
	N/A	If repeatedly happens, call Customer Service.
Calibrated at one temperature, but not at another	N/A	This can be a normal condition when operating temperature varies widely. For maximum accuracy, calibration should be done as close to the set point temperature as possible.

**Note:** N/A is not applicable.



**Table 4. Mechanical Troubleshooting**

Problem	Possible Cause	Solution
Water leaking	Leak	Dry bath and check the tank with flashlight to see if leak is noticeable. Fill tank again and see if leak repeats and find source of leak. Sources may include: fittings that need tightening, crack in outlet tube, or crack in tank. Call Customer Service if these things are noted.
Holes or rust in water bath tank	N/A	Assure that clean, distilled water is used. Deionized water, tap water, and chemicals should never be used in the tank. USE DISTILLED WATER ONLY.
	N/A	Assure that no test sample has leaked into bath water.
	N/A	No metallic products should be in the tank with exception of the oscillation rack.
Rack is not oscillating	N/A	Check if locking pin on rack is securely in the bearing of the reciprocation shaft.
	N/A	Verify that oscillation set point is within specified parameters.
	N/A	Verify that oscillation and power switches are in the ON position.
	N/A	<b>Note:</b> Call customer service if the above suggestions do not solve the problem.

**Note:** N/A is not applicable.

**Table 5. Miscellaneous Troubleshooting**

Problem	Possible Cause	Solution
Controller on at all times - "locked-up"	N/A	Turn unit off and on to reset.
	N/A	If you cannot change any condition on the front panel, call customer service.
Front panel displays are all off	Unit or wall fuse/circuit breaker is blown.	Check for wire damage.
	N/A	Check wall power source.
	N/A	Compare current draw and compare to specs on data plate.
	N/A	See what other loads are on the wall circuit.
Unit will not turn on	N/A	Check wall power source.
	N/A	Check fuse/circuit breaker on unit or in wall.
	N/A	Check all wiring connections, especially around the on/off switch.
Unit is smoking out of the box	N/A	This is not an uncommon occurrence for new units. The elements will burn off protective coatings. Run the bath in a well ventilated area at high temperature for one hour until smoke dissipates.

**Note:** N/A is not applicable.

## PARTS LIST

Description	115V	220V	220 V CE
Digital Speed Control	1751019	1751019	1750563
Digital Temperature Control	1750965	1750966	1750966
Element - SWBR17 SWBR17-2 (WS17 WS17-2)	9570685	9570687	9570687
Element - SWBR27 SWBR27-2 (WS27 WS27-2)	9570686	9570688	9570688
EMI Filter	NA	NA	2800502
Fuse 5 x 20mm	3300516 10A	3300515 6.3A	3300515 6.3A
Gear Motor Assembly	9600619	9600619	9600619
Oscillation Rack, SWBR17 SWBR17-2 (WS17 WS17-2)	9750546	9750546	9750546
Oscillation Rack, SWBR27 SWBR27-2 (WS27 WS27-2)	9750547	9750547	9750547
Oscillation Switch	7850579	7850579	7850579
Over temperature Safety Thermostat	1750614	1750614	1750614
Pilot Light	4650549	4650549	4650549
Power Cord	1800529	101990	1800500
Power Inlet	N/A	N/A	4200505
Power Switch	7850570	7850570	7850570
Tank Fitting	3100572	3100572	3100572
Transformer	8350510	8350510	8350510

**Note:** N/A is not applicable.

**Section**  
**10**

# UNIT SPECIFICATIONS

These units are 115 V or 220 V. Please refer to the unit's data plate for its individual electrical specifications.

**Table 6. Weight**

Model	Shipping	Net
SWBR17 SWBR17-2 (WS17 WS17-2)	50 lbs. 22.68 kg	38 lbs. 17.24 kg
SWBR27 SWBR27-2 (WS27 WS27-2)	75 lbs. 34.02 kg	51 lbs. 23.13 kg

**Table 7. Dimension**

Model	Exterior WxDxH	Interior WxDxH
SWBR17 SWBR17-2 (WS17 WS17-2)	25.25 x 15.5 x 12.5 in. 64.25 x 39.37 x 31.75 cm	12.5 x 11 x 6.5 in. 31.75 x 27.94 x 16.51 cm
SWBR27 SWBR27-2 (WS27 WS27-2)	37.5 x 15.5 x 12.5 in. 95.5 x 39.37 x 31.75 cm	24.5 x 11 x 6.5 in. 62 x 87 x 27.94 x 16.51 cm
SWBR17 SWBR17-2 (WS17 WS17-2) Tray	11.4 x 13 x 8 in. 28.95 x 33.02 x 20.32 cm	N/A
SWBR27 SWBR27-2 (WS27 WS27-2) Tray	11.4 x 25.8 x 8 in. 28.95 x 64.26 x 20.32 cm	N/A

**Note:** N/A is not available.

**Table 8. Capacity**

Model	Gallons	Liters
SWBR17 SWBR17-2 (WS17 WS17-2)	4.20	15.9
SWBR27 SWBR27-2 (WS27 WS27-2)	7.61	28.8

**Table 9. Temperature Range**

Model	Range	Uniformity	Sensitivity
SWBR17 SWBR17-2 (WS17 WS17-2)	Amb. +5°C to 80.0°C	± 1°C at 37°C	± .07°
SWBR27 SWBR27-2 (WS27 WS27-2)	Amb. +5°C to 80.0°C	± 1°C at 37°C	± .07°

**Table 10. Oscillation Rate**

Model	RPM
SWBR17 SWBR17-2 (WS17 WS17-2)	20 – 200
SWBR27 SWBR27-2 (WS27 WS27-2)	20 - 200

Table 11. Flask Clamp Capacities

Flask Size	Max. # Clamps	
	SWBR17 SWBR17-2 (WS17 WS17-2)	SWBR27 SWBR27-2 (WS27 WS27-2)
25 ml	24	56
50 ml	18	42
125 ml	9	21
250 ml	8	15
500 ml	5	11
1 L	3	7
2 L	1	4
2.8 L	1	3
4 L	1	2
6 L	1	2

Table 12. Power Requirements

Model	Voltage	Amperage	Frequency
SWBR17 (WS17)	110 - 120	7A	50/60 Hz
SWBR17-2 (WS17-2)	220 - 240	4A	50/60 Hz
SWBR27 (WS27)	110 - 120	9.5A	50/60 Hz
SWBR27-2 (WS27-2)	220 - 240	5A	50/60 Hz

**Section**  
**11**

**SCHEMATICS**

**SWBR17 (WS17) (9851337)**

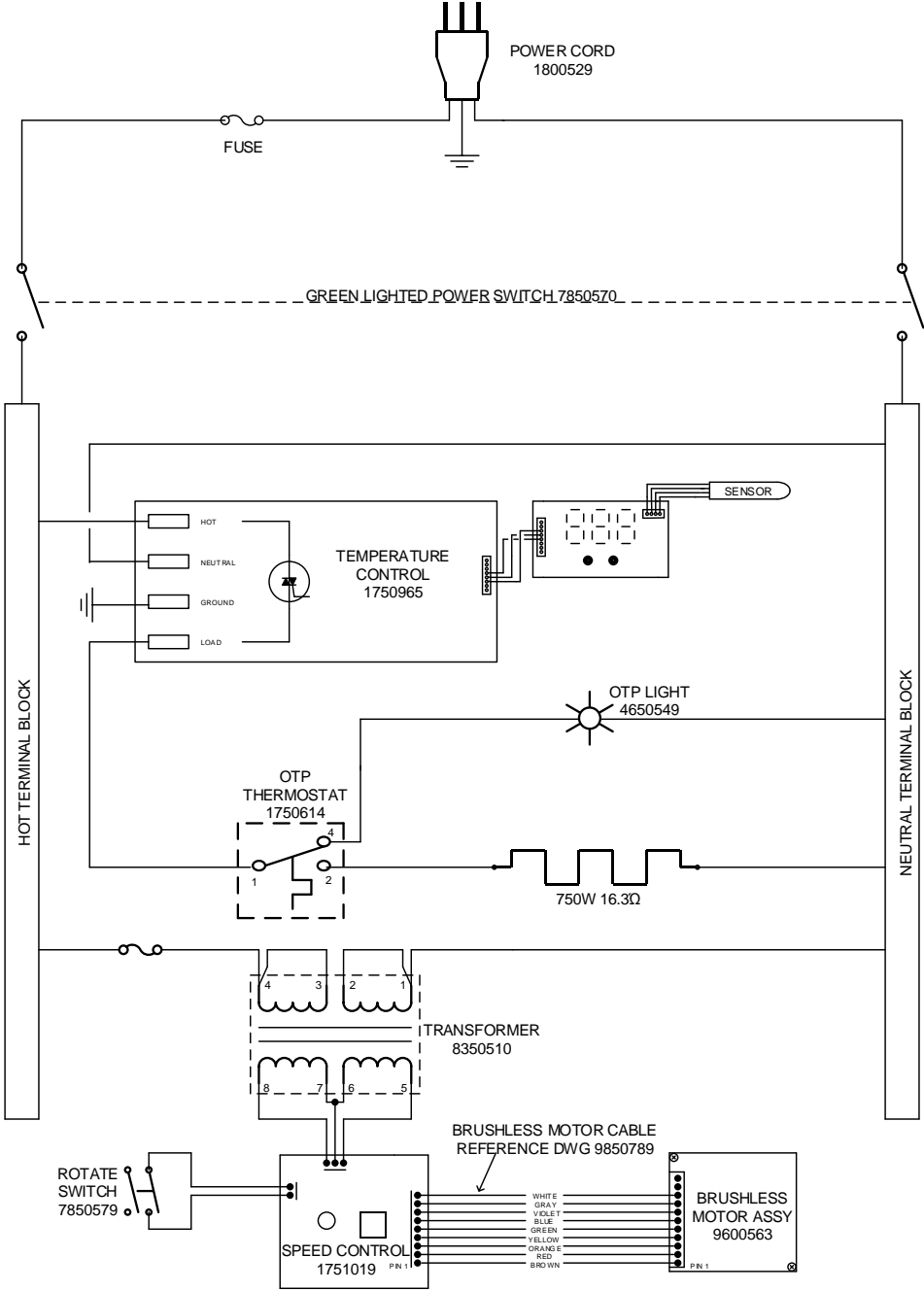

# SWBR17-2 (WS17-2) (9851338)

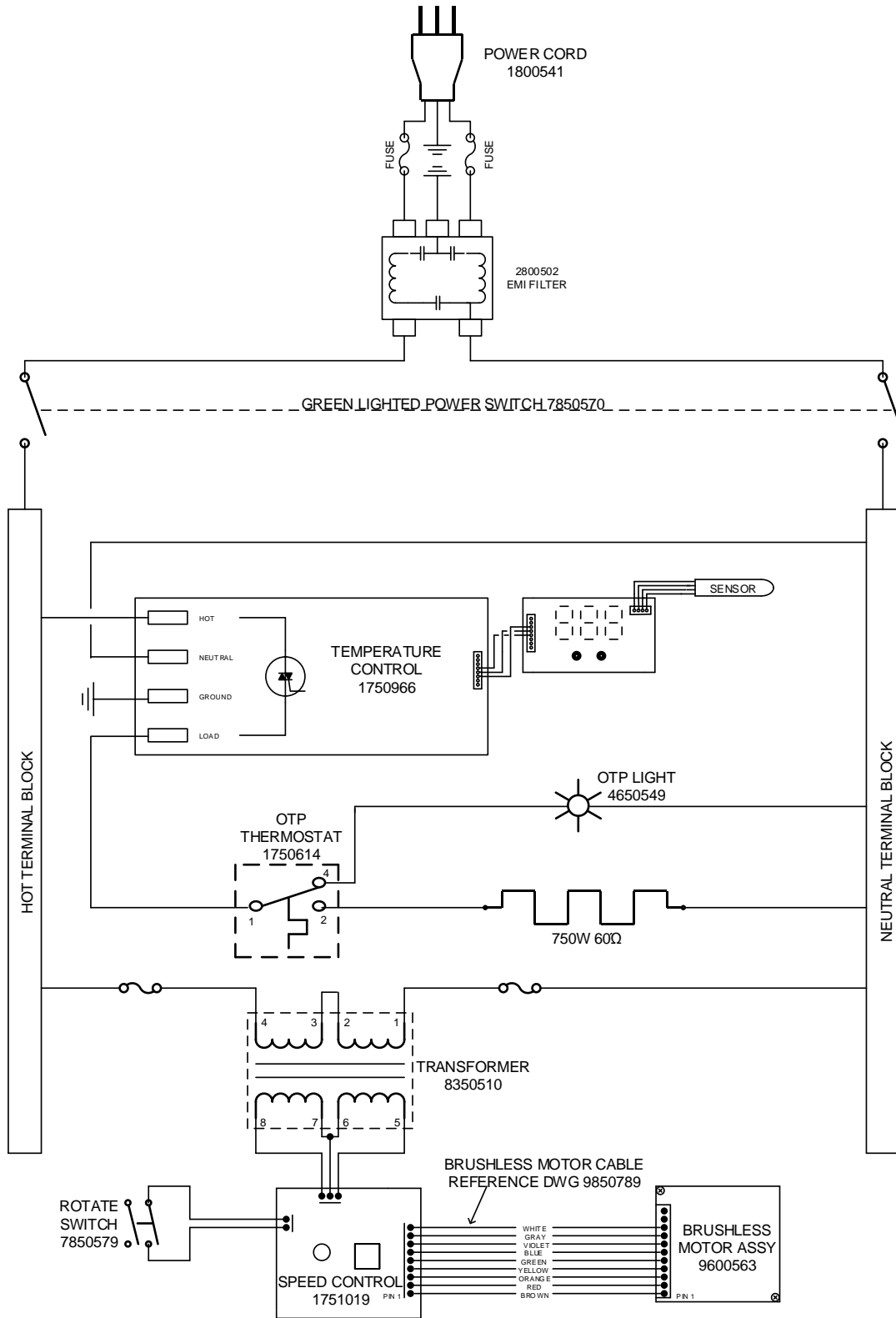

# SWBR27 (WS27) (9851339)

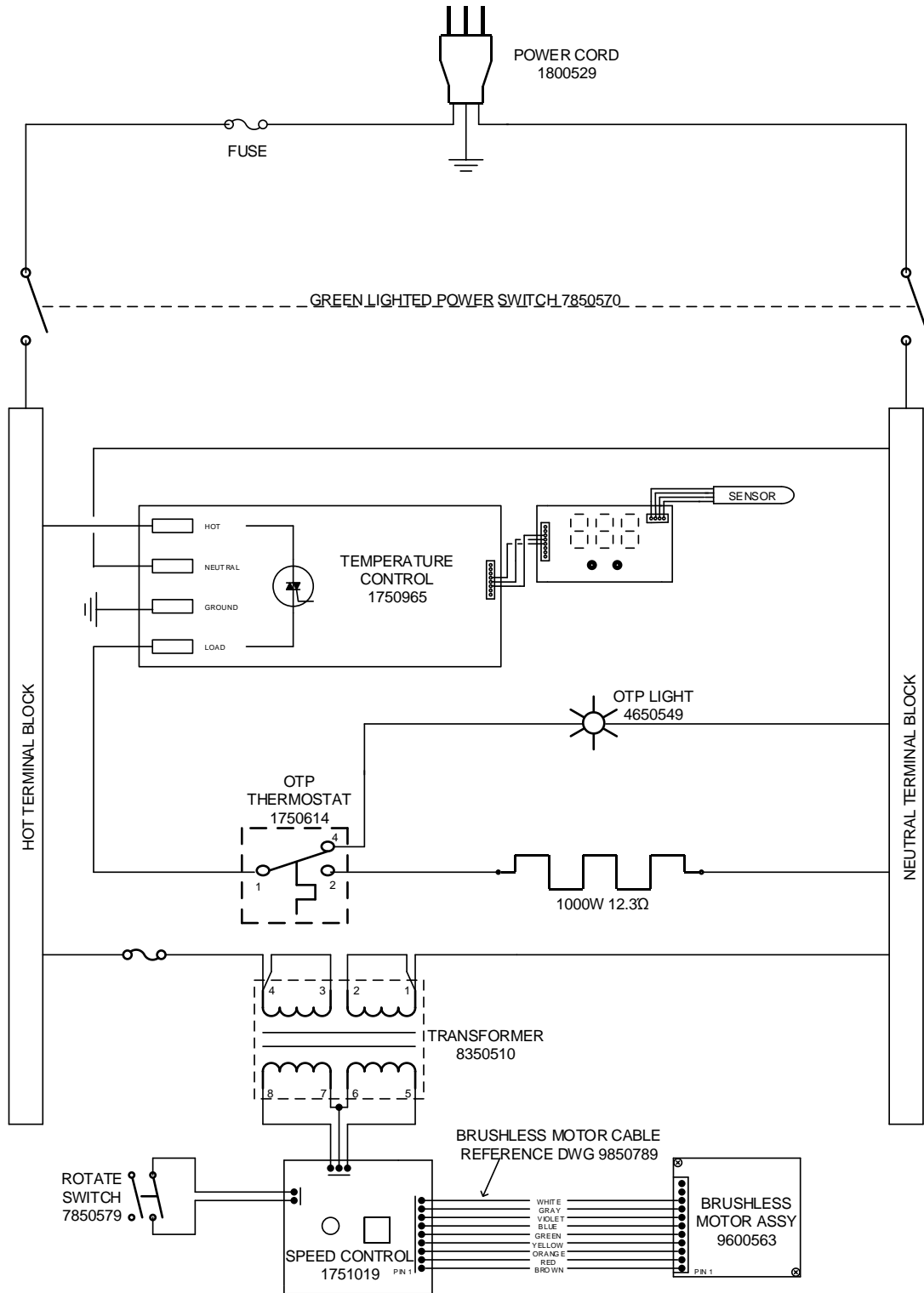

# SWBR27-2 (WS27-2) (9851340)

